

# Radiometer RMD Pro

## Manual



version 1.2.3E

Opsytec Dr. Gröbel GmbH  
Am Hardtwald 6-8  
D-76275 Ettlingen

Telefon: +49(0)7243 / 9 47 83-50  
Fax: +49(0)7243/ 9 47 83-65  
info@opsytec.de

# 1 Table of contents

<b>1</b>	<b>Table of contents .....</b>	<b>2</b>
<b>2</b>	<b>Preface .....</b>	<b>4</b>
<b>3</b>	<b>Directives and Norms .....</b>	<b>5</b>
<b>4</b>	<b>Identification .....</b>	<b>6</b>
4.1	Manufacturer, Ordering of Spares and Customer Service .....	6
4.2	Change history .....	6
4.3	Copyright .....	6
4.4	Device identification .....	6
4.5	Intended use .....	7
4.6	Foreseeable misuse .....	7
4.7	Legal Information .....	8
4.7.1	Limitation of liability .....	8
4.7.2	Declaration of conformity .....	8
4.7.3	Warranty Terms .....	8
<b>5</b>	<b>General .....</b>	<b>10</b>
5.1	Information about this Manual .....	10
5.2	Information about the Symbols .....	11
5.2.1	SAFETY INSTRUCTIONS .....	11
5.2.2	Prohibition Signs .....	12
5.2.3	WARNING SIGNS .....	12
5.2.4	ATTENTION .....	12
5.2.5	Optional functions .....	13
5.3	Owner/operator information .....	13
5.4	Personnel requirements .....	14
5.4.1	Qualifications .....	14
5.4.2	Qualified person .....	14
5.4.3	Operator .....	14
5.4.4	Training and qualification of personnel .....	14
5.5	Personal protective equipment .....	15
5.5.1	Protective gloves .....	15
5.5.2	Safety goggles .....	15
<b>6</b>	<b>Safety instructions and residual risk .....</b>	<b>16</b>
6.1	General .....	16
6.2	Safety instructions in relation to normal operation .....	17
6.3	Maintenance and troubleshooting .....	18
6.4	Safety instructions regarding service and repair work .....	19
6.5	Safety instructions regarding the power supply .....	20
<b>7</b>	<b>Description of the system and functional overview .....</b>	<b>21</b>
7.1	Radiation protection .....	21
7.2	Practical tips .....	22
7.3	Transport, storage, delivery .....	23

7.4	Commissioning .....	23
<b>8</b>	<b>Operation .....</b>	<b>24</b>
8.1	Switch on .....	25
8.2	With the RMD Measuring.....	25
8.2.1	Measurement screen.....	25
8.2.2	Switching measuring modes .....	28
8.3	Menu .....	30
8.3.1	Data recording .....	31
8.3.2	Settings.....	32
8.3.3	Change times .....	34
8.3.4	Change date and time .....	35
8.3.5	Information .....	36
8.3.6	Change language .....	36
8.3.7	USB refresh.....	37
8.4	Data recording .....	38
8.4.1	Data recording on the SD card.....	38
8.4.2	Data recording via USB.....	40
8.5	Additional lamp factors* .....	42
8.6	Sensors with 2 channels: Erythem und NDT* .....	42
8.6.1	Erythema sensor .....	43
8.6.2	NDT .....	43
8.7	Switch off .....	44
8.8	Charging the battery .....	44
<b>9</b>	<b>Software .....</b>	<b>45</b>
9.1	Installing software .....	45
9.2	Operation .....	45
9.2.1	Device control and information.....	46
9.2.3	Measurement .....	47
9.3	SD card and data export.....	48
<b>10</b>	<b>Technical data .....</b>	<b>49</b>
<b>11</b>	<b>Errors / faults.....</b>	<b>51</b>
<b>12</b>	<b>Maintenance &amp; Cleaning .....</b>	<b>52</b>
12.1	Calibration.....	53
12.2	Firmware update.....	53
<b>13</b>	<b>Spare parts .....</b>	<b>55</b>
<b>14</b>	<b>Declaration of conformity .....</b>	<b>56</b>
<b>15</b>	<b>NOTES.....</b>	<b>57</b>

## 2 Preface

Dear Customer!

Thank you for choosing a product manufactured by us!

Please take your time to read this manual carefully. Please pay special attention to the safety instructions.

This is the condition for safe handling and safe operation of the system and its components.

If you have any questions that you do not find answered in this manual, please call us and we will be pleased to assist you. In addition, we always welcome any suggestions or proposals for improvement.

Our products undergo constant advanced development; therefore there may be minor differences between your system and the illustrations given in this Operating Manual.

THIS MANUAL CONTAINS IMPORTANT SAFETY INSTRUCTIONS.  
KEEP THIS MANUAL.

© 2021

Opsytec Dr. Gröbel GmbH

At Hardtwald 6-8

D – 76275 Ettlingen

Phone: +49(0)7243 / 9 47 83-50

Fax: +49(0)7243 / 9 47 83-65

[info@opsytec.de](mailto:info@opsytec.de)

All rights reserved. Reprinting, including excerpts, is only permitted with the written consent of Opsytec Dr. Gröbel GmbH.

This is a translation of the original operating manual.

### 3 Directives and Norms



The system is machinery under Annex II A of the Machinery Directive and is therefore delivered with a declaration of conformity and with a CE mark (in accordance with the Machinery Directive).

Guidelines	
EC Directives	06/42/EC (Machinery) (partially observed) 2014/30/EC (EMC) 2014/35/EC (Low voltage)
Harmonized standards	
EN 61000-6-2:2005	Electromagnetic Compatibility (EMC) – Part 6-2: Immunity for Industrial Environments
EN 61000-6-4:2007 + A1:2011	Electromagnetic Compatibility (EMC) – Part 6-4: Emission Standard for Industrial Environments

## 4 Identification

### 4.1 Manufacturer, Ordering of Spares and Customer Service

Opsytec Dr. Gröbel GmbH  
 Am Hardtwald 6-8  
 D – 76275 Ettlingen  
 Tel.: +49(0)7243 / 9 47 83-50  
 Fax: +49(0)7243 / 9 47 83-65  
[info@opsytec.de](mailto:info@opsytec.de)  
[www.opsytec.com](http://www.opsytec.com)

### 4.2 Change history



We reserve the right to make changes in content. Opsytec Dr. Gröbel GmbH is not liable for any errors in this documentation. No liability shall be accepted for indirect damages arising from the delivery or use of this documentation, in as far as this is legally permissible.

Version	Editor	Date	Change
1.0.0E	Paravia	16.03.2020	Translation
1.2.0E	Krieg	17.09.2020	sensors Erythem und NDT
1.2.1E	Rau	09.11.2020	Software
1.2.2E	Paravia	01.12.2020	USB programming added
1.2.3E	Paravia	02.06.2021	Ed. changes

### 4.3 Copyright



Opsytec Dr. Gröbel GmbH shall retain the copyright for these operating manual. The operating manual is intended for the owner/operator and his personnel.

#### Copyright in accordance with DIN ISO 16016:

Reproduction and copying of this document, use and disclosure of its contents are prohibited unless expressly authorized.  
 Non-compliance may result in a claim for damages. All rights reserved in case of registration of patent, utility patent, or design patent.  
 Contraventions may be subject to prosecution.

### 4.4 Device identification

Information for internal use:

Description of the machine:	.....
Year of manufacture:	.....
machine no.	.....
project number	.....

## 4.5 Intended use

The RMD Pro determines, with the corresponding sensors, the irradiance and dose in the UV and VIS spectral range and shows it on the integrated display. Operation is only allowed in dry environment. If required, the sensors are available splash-proof to IP65.

When using the sensors, light, IR and UV radiation can be reflected and scattered. If necessary, suitable protective measures must be taken to protect against radiation.

The system is intended exclusively for industrial use in ordinary locations as defined by the National Electric Code (NEC), NFPA 70. It is prohibited to use the equipment in hazardous areas or for general lighting.

It is prohibited to use the devices in explosive environments or for general lighting

- Installation, commissioning, operation, maintenance and service work may only be carried out by trained and qualified personnel who comply with all safety guidelines and standards.
- Responsibility: Damage resulting from unintentional or unauthorized interference terminates any right to make warranty or liability claims against the manufacturer.
- Exclusion of warranty: The use of any non-original parts invalidates the warranty.
- Environmental protection: Defective parts containing environmentally harmful substances must be disposed of accordingly.
- Only suitable for operation in closed rooms.
- Before opening, the system must be disconnected from the power supply and it must be checked that no voltage is present.
- Wear gloves for cleaning the sensors.
- Any use other than that mentioned above will result in damage to the product. It is also associated with hazards such as short circuits, fire and electric shock. The entire device must not be changed and/or modified! The safety instructions must be observed at all times.

## 4.6 Foreseeable misuse

The following is considered to be foreseeable misuse:

- Operation of the device without safety devices and equipment.
- Work on the device by untrained personnel.
- Non-compliance with the owner/operator's operating instructions.
- Ignoring of the operating manual.
- Processing of materials other than those specified in the technical data.
- Any other use outside the intended specified use.

## 4.7 Legal Information

### 4.7.1 Limitation of liability

All information in this manual has been compiled taking into account the currently applicable standards and regulations, the technical standard and our many years of knowledge and experience.

The manufacturer is not liable for damages in case that:

- This manual is ignored,
- The device is improperly used,
- Untrained personnel is deployed,
- Untrained personnel operates the machine incorrectly,
- Unauthorized modifications are made,
- Technical changes are made,
- Unauthorized modifications are made,
- Non-observance of the instructions in the manual regarding safety, transport, storage, assembly, commissioning, operation and maintenance
- Improperly performed repairs
- Impact of foreign bodies or mechanical damage

We shall not be liable for common faults of the device caused by power outage or failure of the control system.

The actual scope of delivery may be different than the explanations and pictures in this manual in case of special versions, when additional options are ordered or due to the latest technical changes.

The obligations agreed in the delivery contract, as well as the legal requirements valid at the time the contract was concluded shall apply.

### 4.7.2 Declaration of conformity

The declaration of conformity is in the annex or can be requested from the manufacturer.

### 4.7.3 Warranty Terms

The warranty terms and guarantee conditions are governed by the German Civil Code (BGB). The warranty period is one year unless otherwise agreed in the purchase documents.

Warranty and liability claims are excluded if they are due to one or more of the following causes:



- 
- Improper use
  - Improper assembly, commissioning and operation
  - Non-observance of the instructions in the manual regarding safety, transport, storage, assembly, commissioning, operation and maintenance
  - Unauthorised spare parts have been used
  - technical modifications have been made
  - Improperly performed repairs
  - Impact of foreign bodies or mechanical damage
  - act of nature beyond control

We expressly reserve the right to make technical changes that serve to improve or increase the safety standard without separate notification.

## 5 General

### IMPORTANT SAFETY INSTRUCTIONS

**WARNING** - Always observe the following basic precautions when using electrical equipment:

- a) Read all instructions before using the device.
- b) This device may only be used by qualified and trained personnel. See the training section of this manual.
- c) Do you know how to switch off the product? Become thoroughly familiar with the controls.
- d) Stay alert - observe what you do.
- e) Do not use the product if you are tired or under the influence of alcohol or drugs.
- f) Keep the danger zone away from all persons.
- g) Do not place the device on an unstable surface.
- h) Follow the maintenance instructions given in the user manual.
- i) Keep this manual in a safe place.

### 5.1 Information about this Manual

This manual intends to make handling of this system and its components safe and efficient. The manual is part of the system and must be kept in its immediate vicinity where it is accessible for the personnel at any time.

This documentation contains the necessary information for the intended use of the described system. It is intended for technically qualified personnel who have been especially trained for operation, laboratory use, quality assurance, service and repair.

The personnel must have read this manual carefully and understood its content before commencing any work. The basic condition for safe working is observation of all stated safety information and operating instructions in this manual.

Knowledge and technically faultless implementation of the instructions, safety requirements, safety information and warnings are a condition for safety in operation, service and repair. Only qualified personnel has the required professional knowledge to apply the safety requirements, safety information and warnings stated in this operating manual in a general way correctly in a concrete situation.

In addition, the local accident prevention regulations and general safety regulations apply for the area of application of the system.

Illustrations in this manual serve the purpose of general understanding; they may differ from the actual version.

Apart from this manual the instructions for the installed components included in the appendix apply.

This operating manual cannot take any possible case of maintenance into account. If you need further information or if special problems occur that are not treated extensively enough in this manual please request the required information from the manufacturer.



For a simple description, the above mentioned components are collectively referred to as system.



## 5.2 Information about the Symbols



### 5.2.1 SAFETY INSTRUCTIONS



In this manual, safety information is indicated by means of symbols. Safety information is preceded by signal words that indicate the scope of risk.

To avoid accidents and damage to persons or property, always follow the information and act prudently.

Throughout the text, you will find the following pictograms with the following meanings:

	 <b>DANGER</b>
	<p><b>Imminent danger</b> Possible consequences: death or most serious injuries.</p> <ul style="list-style-type: none"> <li>• Prevention</li> </ul>

	 <b>WARNING</b>
	<p><b>Dangerous Situation</b> Possible consequences: death or most serious injuries.</p> <ul style="list-style-type: none"> <li>• Prevention</li> </ul>

	 <b>CAUTION</b>
	<p><b>Possible Situation</b> Possible consequences: slight or minor injuries. Sometimes also used for warning of material damage.</p> <ul style="list-style-type: none"> <li>• Prevention</li> </ul>



#### **Note**

Information for use or useful important information

## 5.2.2 Prohibition Signs



General "Prohibited-sign"

## 5.2.3 WARNING SIGNS



Warning of optical radiation  
(such as UV, IR, or visible radiation)



Warning about electricity!

## 5.2.4 ATTENTION



Wear eye protection!



Opaque eye protection must be worn!



Disconnect the power plug from the socket!



Disconnect before carrying out maintenance or repair!



Use hand protection!



Refer to the instruction manual/booklet

### 5.2.5 Optional functions

- \* Optional functions, not available for every system

## 5.3 Owner/operator information

The System is used in the commercial sector. The owner/operator of the system is therefore subject to the legal obligations concerning work safety.

In addition to the safety information in this manual, the generally applicable regulations valid for the application area of the system concerning safety, prevention of accidents and for protection of the environment must be noted and complied with.

The following applies in particular:

The owner/operator must acquire information about the valid occupational health and safety information and in a risk assessment determine additional hazards incurred due to the special operating conditions at the location of use of the system. He must implement these in the form of operating instructions for operation of the system and specifically for the individual work stations.

The owner/operator is obliged to check during the entire lifetime of the system whether the operating instructions that he generated comply with the current status of the regulations and update them if necessary.

The owner/operator must assign and define the responsibilities for installation, operation, rectification of faults, service and cleaning unambiguously.

The owner/operator must ensure that all personnel dealing with the system have read and understood this manual. Furthermore, he is obliged to provide personnel training in regular intervals and provide information about risks.

The owner/operator must provide the required personal protective equipment for his personnel. Furthermore, the owner/operator is responsible that the system is always in faultless technical condition. To ensure this, the service intervals specified in this manual and in the technical documents for the individual systems must be observed and all safety installations must be checked regularly for function and completeness.



The owner/operator must have all safety devices checked regularly for function and completeness.

The owner/operator must ensure that the operating personnel have knowledge about first aid measures and local rescue installations.

## 5.4 Personnel requirements

The maximum number of qualified professionals who may be present at the site at the same time: 2

### 5.4.1 Qualifications

 <b>WARNING</b>	
	<p><b>Risk of injury when personnel are insufficiently qualified!</b></p> <p>If unqualified personnel carries out work on the system or stays in the danger area of the system risks arise that may cause severe injuries and serious material damage.</p> <ul style="list-style-type: none"><li>• Have all activities carried out only by personnel qualified for the activity.</li><li>• Keep unqualified personnel away from the danger area.</li></ul>

Below, this manual lists the qualifications of the personnel for the various areas of activity:

### 5.4.2 Qualified person

Qualified persons are trained or can be trained by Opsytec Dr. Gröbel GmbH in extended operation and parameterization of the system as well as in execution of preventive service work.

In addition, due to their technical training, knowledge and experience and knowledge of the relevant standards and regulations, they are able to carry out work they have been assigned and to recognize and avoid possible risks independently.

### 5.4.3 Operator

Operators use and operate the system in the scope of the intended use. They are trained by the owner/operator in the work assigned to them and informed about possible risks.

### 5.4.4 Training and qualification of personnel

In regular instructions and training, operating personnel must be informed about the special risks when working with and handling the system.

The instruction and training should have the following content:

Hazards when working with the system in normal operation.

Hazards in connection with service, repair and cleaning activities.

Conduct to minimize consequences of accidents.

Conduct in case of accidents.

Rescue of injured persons.

Working without personal protective equipment may cause health damage. The company supervisor is instructed to pay attention that personnel are wearing personal protective equipment.

Instruction and training must be carried out in regular intervals by the owner/operator. For better tracking, execution of instruction and training should be recorded.

## 5.5 Personal protective equipment

The purpose of personal protective equipment is to protect personnel from hazards that could affect their safety or health when working with the RMD Pro and UV lamps, LEDs or lights.

When performing various activities on and with the system, personnel must wear personal protective equipment. This is pointed out repeatedly in the individual chapters of this manual. The personal protective equipment is explained below:

### 5.5.1 Protective gloves

Protective gloves are used to protect the hands from visible and/or invisible radiation, friction, abrasions, stitches and deep injuries.

### 5.5.2 Safety goggles

Safety glasses are used to protect the eyes from visible and/or invisible.

Safety glasses and storage boxes can be ordered from Opsytec Dr. Gröbel GmbH, Am Hardtwald 6-8, 76275 Ettlingen, Germany or UVEX AREITSSSCHUTZ GMBH, Würzburger Str. 181 - 189, 90766 Fürth, Germany:

Protective eyewear part number: 9169065

Storage box part number: 9957502

	<b>⚠ CAUTION</b>
	Use eye protection when working with the light source in the danger zone.

	<b>⚠ CAUTION</b>
	Store the safety glasses in a protected place at the place of use when not in use.

## 6 Safety instructions and residual risk

### 6.1 General

The system is state-of-the-art and has been built in compliance with recognized safety regulations. Nonetheless, its use may constitute risks for life and limb of the operating and repair personnel (service personnel) or third parties or impairments to the machine. Operate the system only when its safety devices are in faultless condition. Disruptions that impair its safety must be rectified at once.

The following safety information must be strictly observed to prevent damage to the machine and personal injury!

	<b>⚠ WARNING</b>
	<p><b>Risk of injury if personnel do not read the operating manual!</b>          Before commissioning and operation, read the operating manual completely. Read all safety notes and instructions. Failure to follow the safety warnings and instructions may result in electric shock and/or serious injury.</p>

	<b>CAUTION</b>
	<p><b>Material damage due to kinking of the cables</b>          If you bend the cables too much, cable breaks may occur. This can lead to impairment up to Lead the cables through the functional inaccessibility.          -avoid bending or kinking the cables too much.          -Lay the cables together in a wide circle.</p>

	<b>CAUTION</b>
	<p><b>Material damage due to improper handling</b>          If you carry the sensors on the cable, material damage may occur over time. This can lead to malfunctions or even to the sensors not functioning properly.          -Pick up the sensors for transport.</p>



<b>CAUTION</b>	
	<p><b>Material damage due to high temperatures</b></p> <p>If the sensors are exposed to high temperatures, material damage may occur.</p> <p>This can lead to impairments or even to the inoperability of the sensors.</p> <p>-The sensors may be exposed to max. 60 °C.</p> <p>-If necessary, do not expose the sensors to radiation for long periods of time to avoid overheating.</p>

## 6.2 Safety instructions in relation to normal operation

Never look directly into LEDs, lamps or UV lamps.

The RMD Pro itself does not emit any hazardous radiation.

Safety for persons working with UV radiation:

The wearing of personal protective equipment (e.g. safety goggles and hand protection) is generally recommended when measuring LEDs, lamps or UV lamps. Wear personal protective equipment to protect eyes and skin if you cannot ensure complete shielding of UV radiation.

Safety glasses used must comply with the EN 170 standard (max. spectral transmission (365 nm) 0.3%) and provide protection against direct and lateral radiation.

Attach warning signs to the work area and all access points.

Demarcate the working area for manual workstations or mobile use accordingly.

The risk assessment for a UV workstation is the responsibility of the customer. This requires measurements / assessments according to DIN EN 14255-1:2005-06 "Measurement and assessment of personal exposures to incoherent optical radiation - Part 1: Ultraviolet radiation emitted by artificial sources in the workplace".

DIN 14255-1 itself does not contain any limit values. These are given in Directive "2006/25/EC of the European Parliament and of the Council on minimum health and safety requirements regarding the exposure of workers to risks arising from physical agents (artificial optical radiation)".

<b>CAUTION</b>	
	<p><b>Risk of damage</b></p> <ul style="list-style-type: none"><li>• Skin grease and dirt are absorbent in the UV and visible spectral range.</li><li>• Avoid fingerprints on the optically active sensor surface. If necessary, the components must be carefully cleaned with isopropanol.</li></ul>

### 6.3 Maintenance and troubleshooting

The chapter "Maintenance" describes all necessary work, the regular execution of which ensures reliable operation.

Apart from the measures described in this manual, no unauthorized repairs or modifications may be carried out. Furthermore, no changes, additions or conversions may be made without the manufacturer's approval.

If a fault occurs which cannot be rectified using the instructions, contact the manufacturer's customer service department.

In addition, carry out regular maintenance, servicing and cleaning work to ensure a technically perfect condition and increase the service life.

Eliminate immediately any faults that impair safety.

Immediately replace components and parts that are not in perfect condition.

Operation is not permitted if there is visible damage to the device.

## 6.4 Safety instructions regarding service and repair work

<b>CAUTION</b>	
	<p><b>Risk of damage</b></p> <ul style="list-style-type: none"><li>• Skin grease and dirt are absorbent in the UV and visible spectral range.</li><li>• Avoid fingerprints on the optically active sensor surface. If necessary, the components must be carefully cleaned with isopropanol.</li></ul>

Service, repair and cleaning work may only be carried out by authorised and specially trained specialists. The system must be de-energized and secured before major work (including cleaning) is carried out).

Perform the prescribed adjustment, service and inspection work according to the plan.



Only qualified electricians may carry out work on the electrical system.

Safety devices may only be removed during service and repairs if the system has been previously switched off and brought into a safe condition.

During service and maintenance work, important safety installations may no longer function. This type of work therefore requires special care.

## 6.5 Safety instructions regarding the power supply

The device is powered by lithium polymer batteries. To recharge the batteries, plug the USB cable into the USB port of the RMD Pro and connect the other end of the cable to the USB interface of a computer or to the mains voltage using the supplied mains adapter.

 <b>WARNING</b>	
	<p><b>Fire hazard from lithium polymer batteries</b></p> <p>If the device is exposed to strong thermal or mechanical influences, the lithium-polymer battery may be damaged.</p> <p>This may cause spontaneous combustion of the battery.</p> <p>Toxic vapours escape and a metal fire is started.</p> <p><b>Avoidance</b></p> <p>Do not use or store the device</p> <ul style="list-style-type: none"><li>-near strong heat sources</li><li>-over 60 °C</li></ul> <p><b>Measures</b></p> <ul style="list-style-type: none"><li>- Don't breathe the fumes.</li><li>-Do not attempt to extinguish the metal fire yourself but inform the fire brigade immediately.</li></ul>



Lithium batteries must be disposed of as hazardous waste. Waste key number: 1606

## 7 Description of the system and functional overview

The RMD Pro radiometer is a development of Opsytec Dr. Gröbel GmbH. More than 30 years of experience in all areas of irradiance and illuminance measurement have gone into this easy-to-use radiometer. It features a wide dynamic range and extremely low noise. For this purpose, the sensor already contains a multi-stage amplification, an extremely precise analogue-digital converter and a temperature sensor. The memory contained in the sensor contains all sensor identifications and the calibration history.

Several sensors for UV radiation and light can thus be operated on the RMD radiometer. A large selection of sensors is available for the most diverse production and control processes. Sensors for evaluating erythema-weighted radiation and multi-channel sensors are also available. Two sensors can be read out simultaneously. Different sensors cover the wavelength ranges from 200 nm to 780 nm. The RMD Pro automatically detects the change of sensors. Simultaneous measurements of different wavelength ranges are also possible.

The newly developed diffuser achieves a very good cosine correction with excellent lateral uniformity. The radiation to be measured is distributed evenly over several channels, so that, for example, the simultaneous determination of UVA irradiances and illuminances is possible.

The measurement data are clearly shown on the graphic display. Operation is via the membrane keyboard and context menu keys.

Compared to its predecessor RMD PRO, the RMD is characterized by a significantly higher resolution of 24 bit, an extended measuring range of up to 7 orders of magnitude, the multi-channel sensors and the simplified operation.

The measured values can be stored in the RMD Pro and output via USB.

The RMD can be controlled from a PC with the associated software. The device can be powered by a rechargeable battery or power supply and records measurement data for up to 100 days at a time. The minimum, maximum and average irradiance, dose and measurement date/time are stored. The batteries are charged via USB.

Applications:

- Measurement of UV LEDs & UV light sources
- NDT, material testing
- Monitoring of UV irradiation systems
- Measurement for workplace safety
- Measurement of  $H_{\text{eff}}$  and  $H_{\text{UVA}}$
- Multi-channel measurements
- Applications with high dynamics
- Data logging

### 7.1 Radiation protection

UV radiation is harmful to humans, so please observe the protective regulations when working. Furthermore, UV-C radiation in particular is destructive to materials. It is therefore advisable not to expose the sensors to excessive radiation. Avoid overloading the sensors and use an aperture in good time.

If the thermal load from the radiators is too great, it may be useful to place a shielding hood over the sensors, which only exposes the receiver surface. In this way the heating of the sensors can be reduced considerably.

## 7.2 Practical tips

The sensors are connected to the RMD Pro via a cable of about 2 m length. This ensures that even when measuring in inaccessible places, readings can be taken easily.

But keep in mind that radiation measurements are not as easy as measuring lengths with a scale. Although the measuring device provides you with a number, this number depends in many ways on your measuring arrangement. For example, the measured value decreases with the cosine of the tilt angle when the sensor is tilted off the axis of the radiator-sensor.

For reproducible measurement results, the environment around the lamp must have constant reflection ratios; the lamp voltage and lamp wattage must remain constant, as must the ambient temperature and the air flow conditions at the lamp. In addition, of course, the measurement position in relation to the lamp must be maintained and - very important - the spectral composition of the lamp must not have changed.

For each type of lamp - UV-A, UV-B or UV-C lamps - the appropriate sensor must be used. The determination of the UV-B and/or UV-C irradiance on UV-A lamps or correspondingly UV-A and/or UV-C irradiance on UV-B lamps naturally leads to incorrect measurements, as the sensors in the adjacent area are still partially sensitive and thus, for example, the very high UV-A content of a UV-A lamp in a UV-B measurement leads to an increase in the measured value.

### The following components are supplied:

- RMD-Pro
- Sensor\* / Sensors\*
- Suitcase\*
- USB power supply
- USB cable
- Software (USB stick)
- Factory calibration certificate, optionally ISO 17025 calibration certificate\*
- this documentation



For simple description, the above components are collectively referred to as a system.



The RMD is available in several variants. If some of the functions described in this manual are not available in your RMD, please contact the manufacturer or distributor for an upgrade.

### The following components are required by the customer:

- Personal protective equipment

### 7.3 Transport, storage, delivery



#### **Sensitive components**

When transporting the system, therefore, make sure that it is not subjected to any load or hard impacts. Store the system according to the technical data - dry and dust-protected.



#### **Check the scope of delivery**

Check the delivered parts for completeness, damage or other conspicuous features. Document any damage found and report it immediately to the manufacturer or supplier.

No liability is assumed for obvious transport damage reported later.



#### **Packaging material**

Please dispose of the packaging material in an environmentally friendly manner.

### 7.4 Commissioning

Ensure appropriate workplace safety, especially from UV radiation







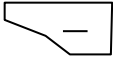
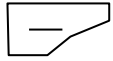

Operate the device only in dry rooms (relative humidity max. 80 %, non-condensing) and in an environment with max. 40 °C). Do not operate the device in hazardous areas, not in dirty, dusty or oily environments.

Protect the device from chemical vapors and solvents, shocks and vibrations, splash water, condensation on its surface and corrosive media.

- Unpack all components and remove the packaging materials.
- Position the sensor(s) at the desired location.
- Connect the sensor(s) to the connectors at the top of the RMD Pro. It does not matter which of the two inputs you plug the sensor into.
- Switch on the RMD Pro.

## 8 Operation

The RMD radiometer is operated via nine keys. These are located on the front side below the display. The keys and the function assignment are shown below:

Button	Function	
	Measuring mode	Menu
	Main menu	OK
	Functions	Back
	Change mode	UP
	Change mode	DOWN
	Change sensor	Menu item back
	Change sensor	Select menu item
	OK	Select menu item
	on/off	
	On/Off Backlight	





## 8.1 Switch on

The device is switched on  with the on/off switch, or by plugging in a USB connection.

After the device has been started, the logo and the current firmware version appear on the display. After approx. 2 s the irradiance measurement appears, if no sensor is connected, a note appears.

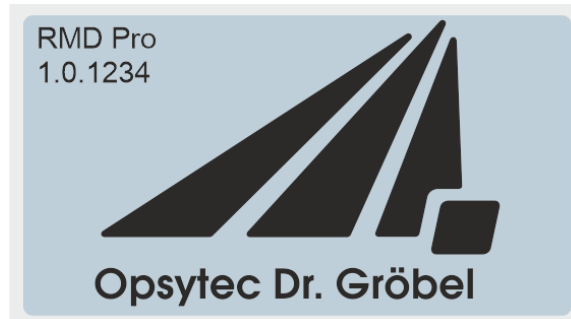

The date and time must be set the first time the device is switched on. See chapter 8.3.4 Changing the time

## 8.2 With the RMD Measuring

The RMD includes three measurement modes: irradiance measurement, dose measurement and min/max measurement.

### 8.2.1 Measurement screen

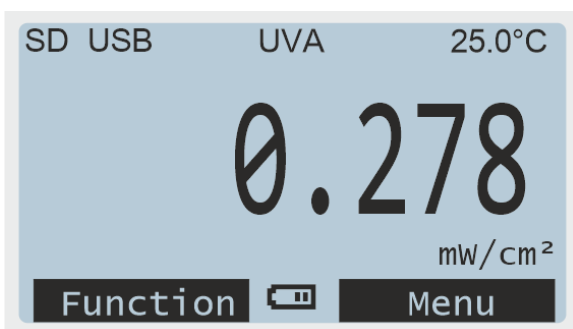

In the upper left corner the status of the SD card and the USB connection is displayed.

The selected sensor or the measuring mode is displayed in the top center.

The sensor temperature is displayed in the upper right corner of the display during irradiance measurement.

One or more measured values and the corresponding unit are shown in the middle.

The battery charge level is shown in the middle of the lower half of the display. The symbol starts flashing when the battery should be charged.

The function key opens a popup menu that contains functions for the respective measuring mode.

With the right menu test the main menu opens (see chapter 8.3)

The measurement screen updates every second.

#### 8.2.1.1 Irradiance

The measured irradiance, or for LUX sensors the illuminance, is displayed in the measurement window. Either each sensor individually or both sensors together can be displayed.

In this mode, the current sensor temperature is displayed in the upper right margin.

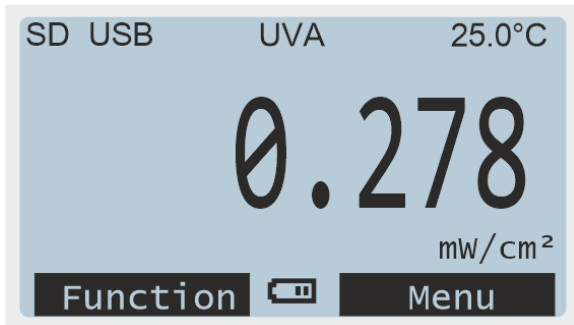

Single measurement Irradiance

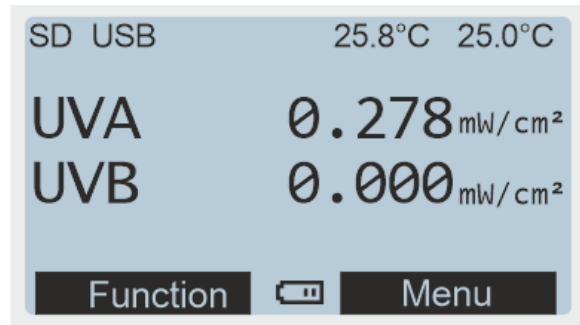

Dual irradiance measurement

If two identical sensors are connected, the channel number appears in the single measurement screen for differentiation.

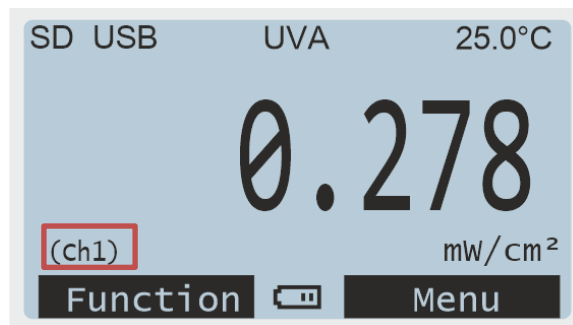

In the function menu of this measuring mode an offset can be set (chapter 8.2.2.1) and the data recording to the SD card (chapter 8.4) can be started.

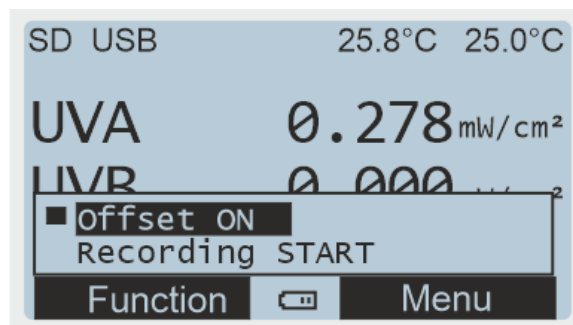

### 8.2.1.2 Dose measurement

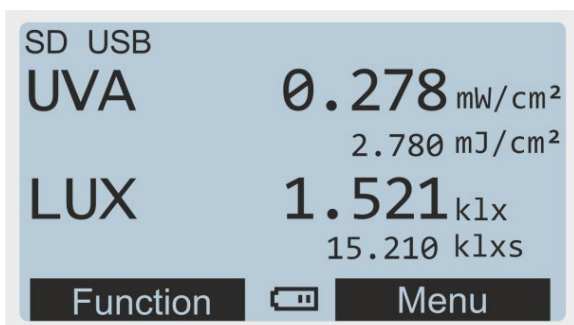

Dual dose measurement

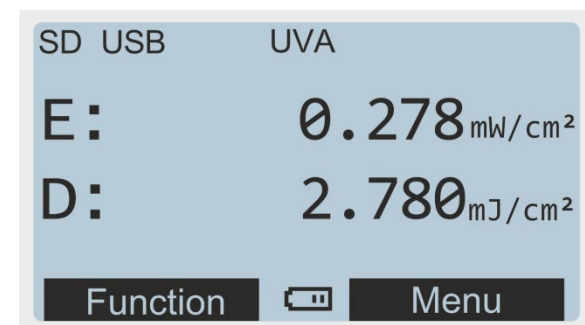

Single dose measurement

A dose measurement can be started, stopped and reset in the dose screen via the function menu. In the dual display, both sensors start the dose recording, in the single view only the one of the displayed sensor. Accordingly, the dose measurement of both sensors or of only one sensor can be stopped / reset.



While the dose measurement is running, the RMD does not switch itself off!

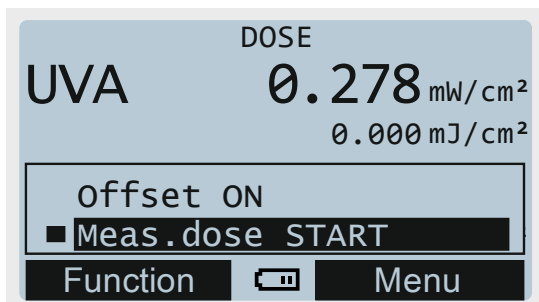

**Measurement dose START:**  
Starts the dose measurement.

(Depending on the setting, data recording to the SD card starts with the start of the dose measurement)

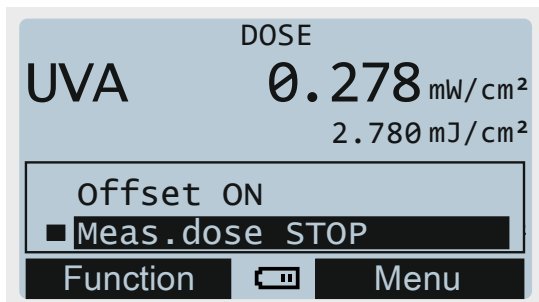

**Measurement dose STOP:**  
The dose measurement is stopped and the measured value remains on the screen until it is reset or a new dose measurement is started.

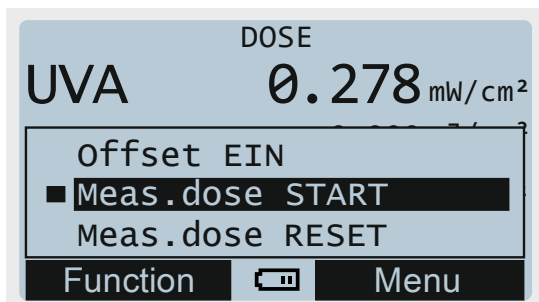

**Measurement dose RESET:**  
A dose reset resets the current dose value.

### 8.2.1.3 Minimum and maximum measurement

Either maximum / minimum measured values and the current measured value for one sensor are displayed or Max. or Min. for both sensors

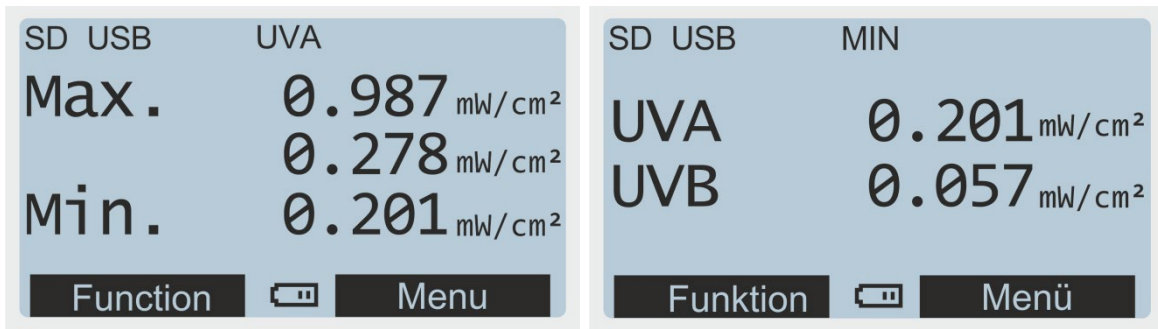

The minimum and maximum value can be reset via the function menu, in the dual display of both sensors, in the single view only of the displayed sensor.

#### 8.2.1.4 Switching measuring modes

The measuring modes can be switched with the arrow keys up and down and the channels are switched  $\triangleleft$  $\triangleright$  left and right.

On a sensor:

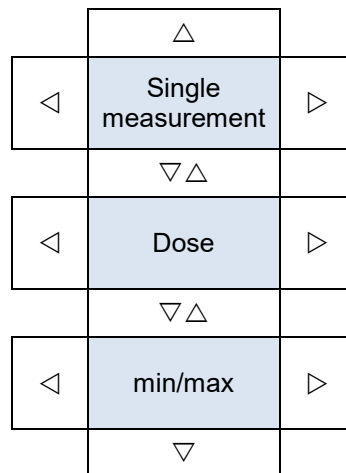

On two sensors:

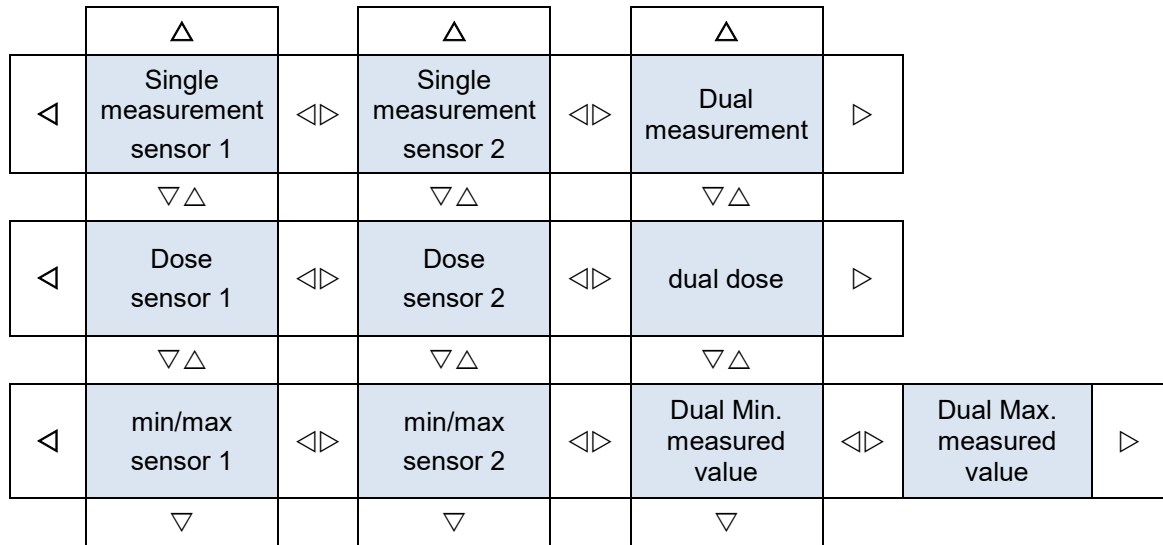

### 8.2.1.5 Offset

An offset can be set in the function menu of each measuring mode. The current measured value is subtracted from the measured value as an offset value. In the dual display an offset is taken from both sensors and in the single view only from the selected sensor.

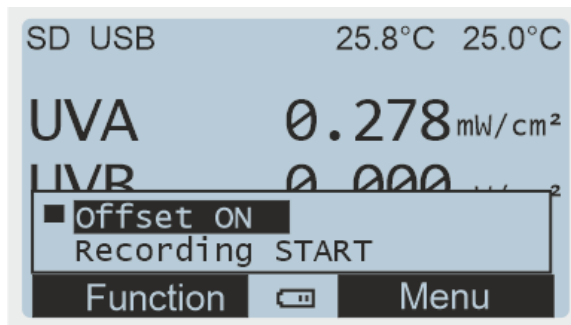

Setting the offset takes about 10 seconds.

If the offset is active, the measured value is displayed with a black background! Example:

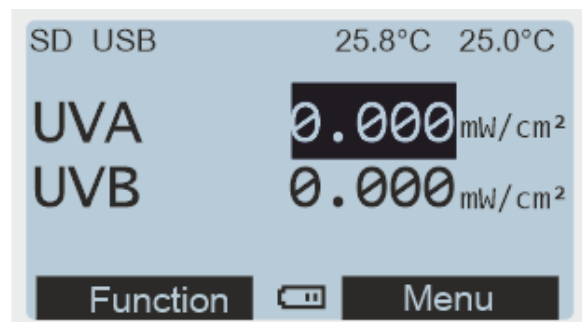
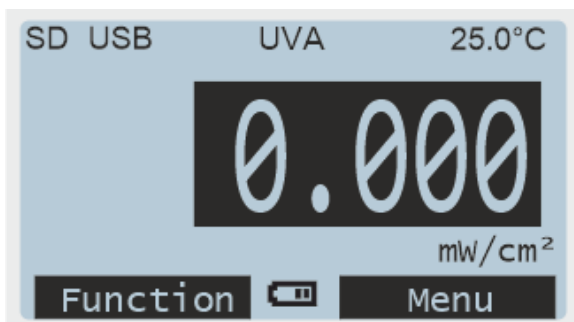

The offset can be deleted or overwritten via the function menu.

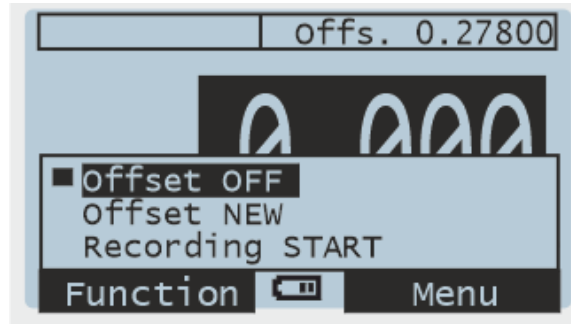

### 8.3 Menu

The main menu is opened in all measuring modes by pressing the right function key

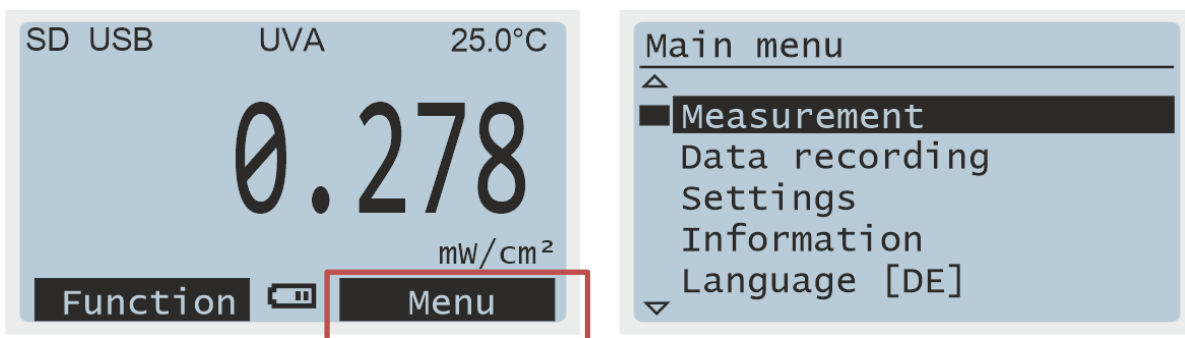

and includes the following points:

• Measurement	back to irradiance measurement	
• Data recording	Settings for data recording to the SD card	Chapter 8.3.1
• Settings	General settings	Chapter 8.3.2
• Information	Sensor and device information	Chapter 8.3.5
• Language	Language setting	Chapter 8.3.6
• Firmware update		Chapter 12.2

### 8.3.1 Data recording

The menu item Data recording contains the settings for recording measurement data to an inserted SD card. You can set the interval at which the data is to be recorded or only manually, the decimal separator can be changed and whether the recording is to be started automatically.

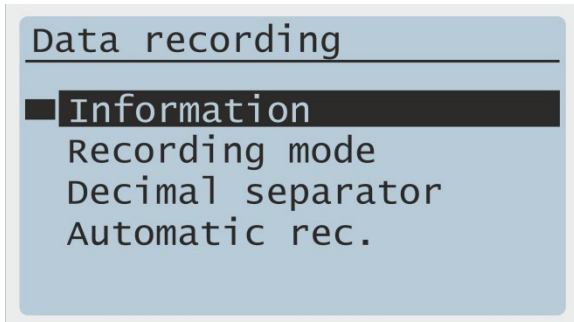

All settings must be confirmed with OK, otherwise they are not accepted!

#### Information:

Shows the current status of data recording. If no data recording is running, the message "No data recording" is displayed.

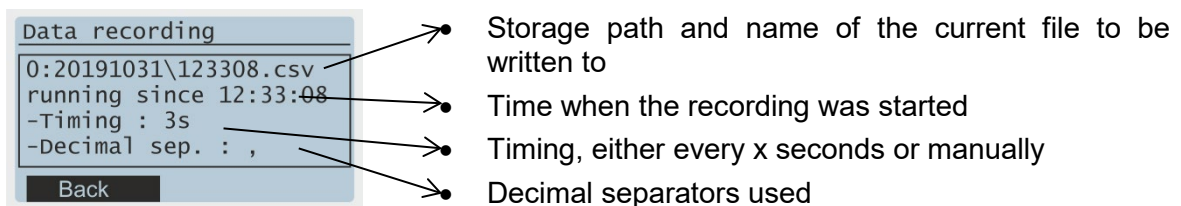

#### Shooting mode:

Determines how often measurement data should be recorded.

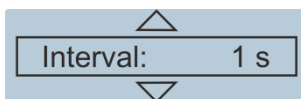

- Every x seconds the measured values are written to the SD card. The time specification can be changed from 1s to 15 min (see chapter 8.3.3)
- The measured values are only written to the SD card if it was started manually (via menu / button). A measured value is always recorded.

**Decimal separator:**

Determines which decimal separator is used for recording. Note: The decimal separator is not automatically switched with the language.

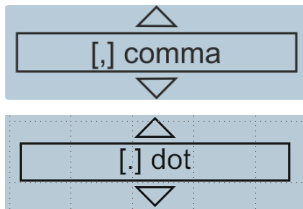

- comma
- dot

**Automatic recording:**

Data recording can be started automatically with the dose measurement.



- If a dose measurement is started in the function menu, a recording to the SD card is also started automatically. The recording must be stopped via the function menu.

When the dose measurement is set to Automatic (**Menu->Settings->Dose->Automatic**), the recording cannot be started automatically!

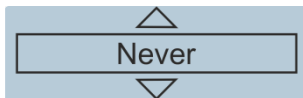

- Recording to the SD card can only be started via the function menu.

**8.3.2 Settings**

The menu item Settings contains general settings for measurement and general settings for the handset.

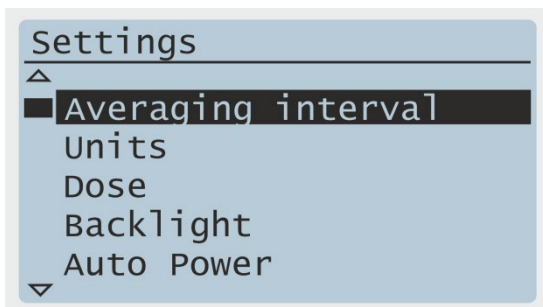

All settings must be confirmed with OK, otherwise they are not accepted!



**Averaging interval:**

period over which the average is calculated:

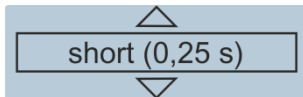

- none (0 s)
- short (0.25 s)
- medium (0.5 s)
- long (1 s)
- maximum (2 s)

no averaging

**Units:**

Unit in which the measured values of the sensors are displayed. This is a setting for the handset that applies to all measured values (including dose).

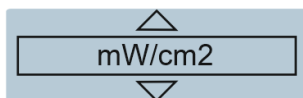

Irradiance

- mW/cm<sup>2</sup>
- W/m<sup>2</sup>
- μW/cm<sup>2</sup>



Lux:

- lx
- klx
- Mlx

**Dose:**

Here you can set whether the dose measurement is started automatically when the handheld device is switched on and a sensor is plugged in or whether it can only be started via the function menu.

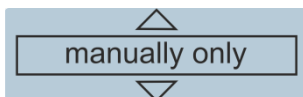

- Manual only

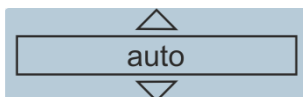

- Automatic: Automatic recording of measured values on the SD card is not possible with the "Automatic" setting.

**Backlight:**

The background light can be switched  on and off at any time with the light button.

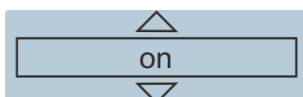

- Backlight is on

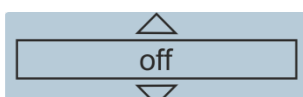

- Backlight is off

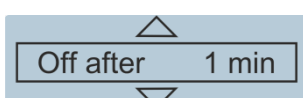

- Off after x min: Backlight goes off after x minutes (see 8.3.3).

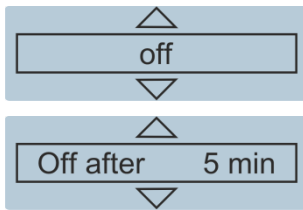
**Car. Power:**

- Off: Device does not switch off by itself.
- Off after x min: Device switches off after x minutes without operation (see 8.3.3) Exception: if data recording from SD or via USB is running.

**Date/time:**

- The instrument has a real-time clock to check the validity of the calibration and to date the measurement.
- To change the time, see chapter 8.3.4.

**Factory settings:**

- By confirming, the device is reset to its original settings and restarted. The time must then be reset. The battery charge state is also reset, this is only correct once the device has been fully charged.

**Firmware update:**

- See chapter Firmware update

**8.3.3 Change times**

To change a timing in the menu, such as the time until the backlight is turned off, is described below:

Switching off the background light should be changed from one minute to five minutes.

Select **Menu** -> Settings -> Backlight -> "Off after x min".

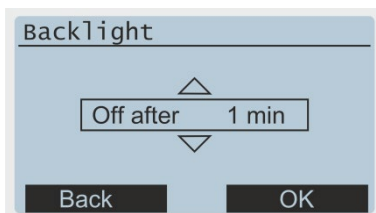

click activates the change mode,  
The number is highlighted in black.

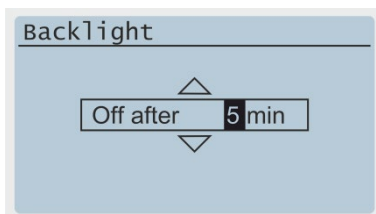

The time can be changed by clicking on .



Clicking repeatedly will exit the change mode.  
By confirming the setting with **OK** the time is taken over.  
Press **Back** or to < discard the change

### 8.3.4 Change date and time

The instrument has a real-time clock to check the validity of the calibration and to date the measurement.

The real time clock can be **set** by clicking **Menu** -> Settings-> Date/Time-> Change.

First set the current date with the keys. Then the month, year, hour and minute setting.

Confirm each time with

Press to < interrupt the settings.

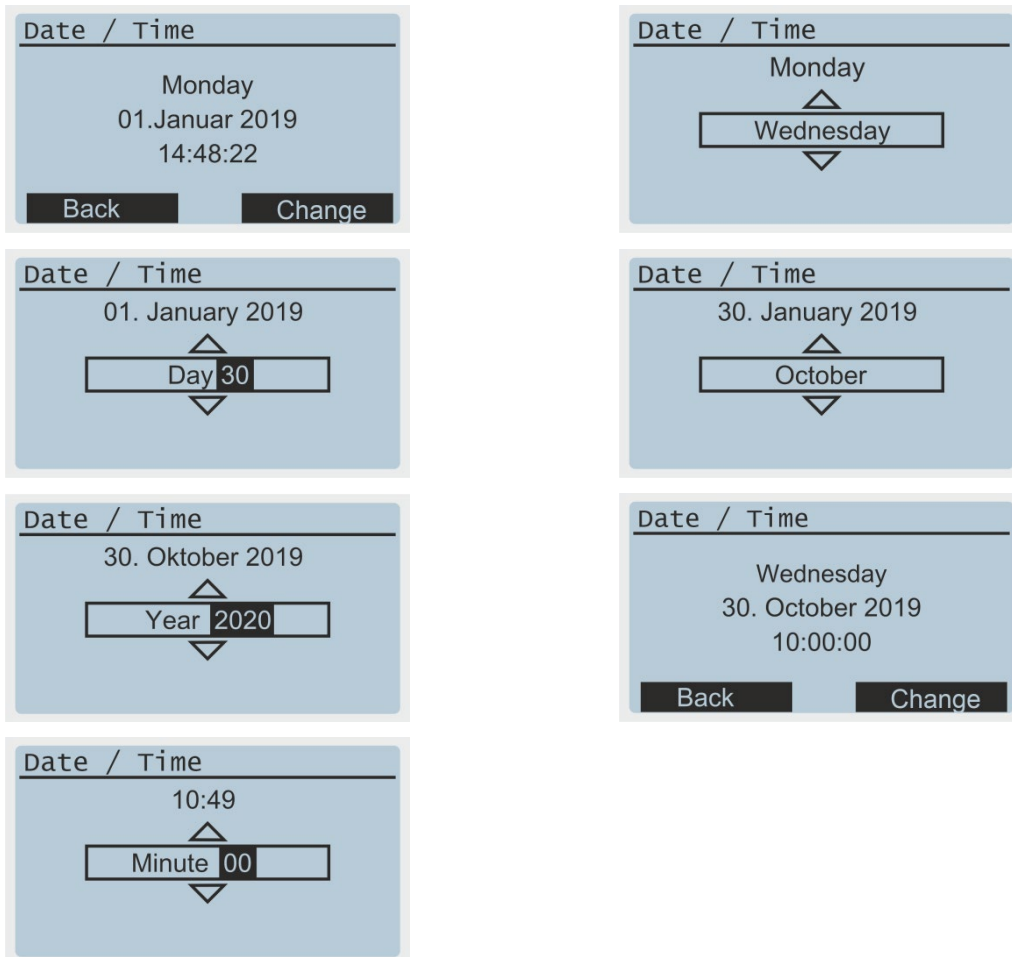

### 8.3.5 Information

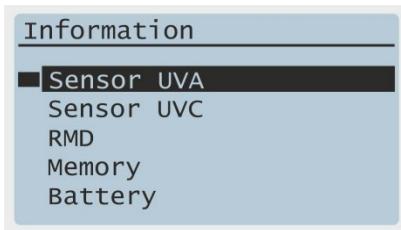

Sensor-specific and device-specific information can be called up under the menu item Information. Only connected sensors appear in the info menu.

#### Sensor:

Display information about the sensor. If no sensor is connected, this menu item is not displayed.

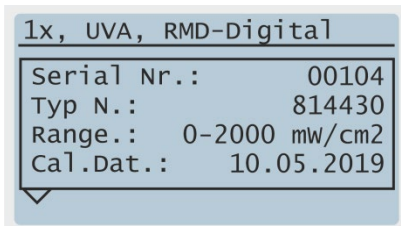

#### RMD:

Display of information about the RMD

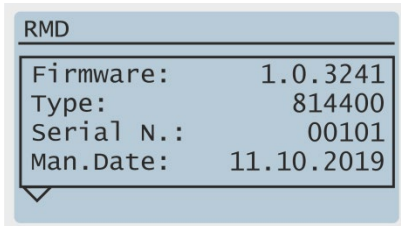

#### Memory:

In the Info window about the memory, the status of the SD card and the available free memory is displayed.

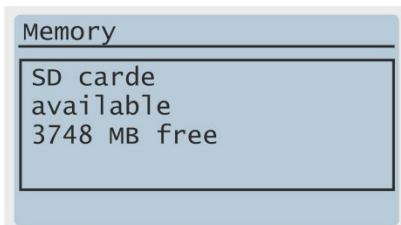

#### Battery:

Display of battery voltage, capacity, charge / discharge current and temperature.

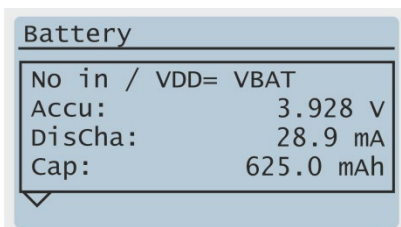

### 8.3.6 Change language

This menu item allows you to switch the system language between German and English. In the main menu the current language is displayed in brackets.

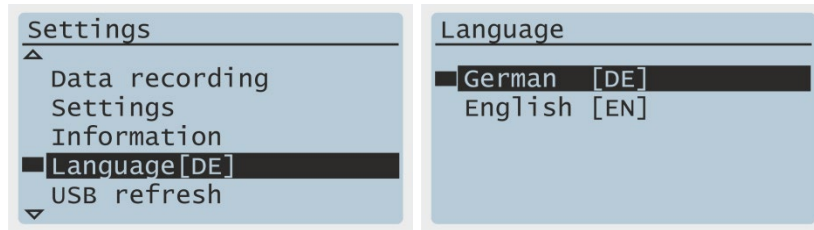

### 8.3.7 USB refresh

The menu item "USB refresh" is used to refresh the display of the SD card as a mass storage device on the software side and to display newly added files.

The COM connection with the PC is also renewed, the function should not be performed if the data display via USB or the use of the software. It takes a few seconds to renew the USB connection.

## 8.4 Data recording

### 8.4.1 Data recording on the SD card

Data recording to the SD card can be started and stopped in any measuring mode via the function menu. It can also be started automatically at the start of a dose measurement (setting under: **Menu** -> Data recording -> Automatic recording -> During dose measurement)

The measurement data are stored on the SD card, which can be read out either directly on the PC or via the RMD on the PC.

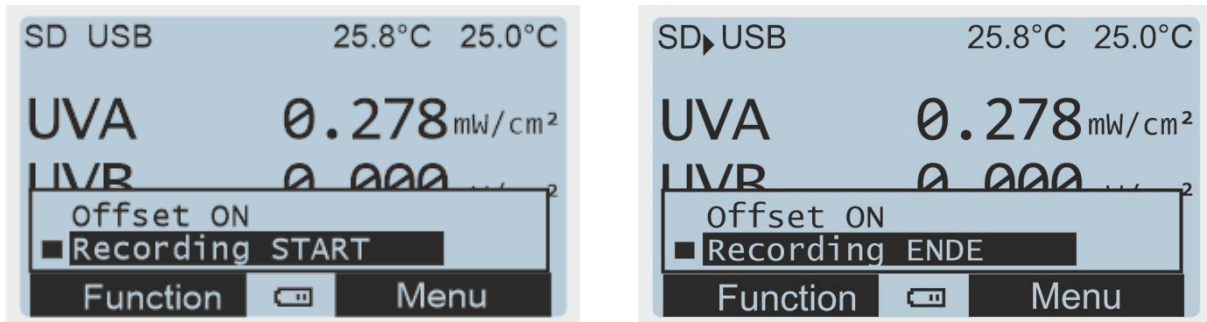

At the beginning and end of the recording, the data path appears on the display. The file name consists of the start time and the storage folder consists of the date. The setting of the current recording, including file name, can be changed under

**Menu** -> Data recording -> Information can be displayed.

There are two modes for data recording. The mode can be set in

**Menu** -> Data recording -> Recording mode can be changed.

Interval mode: Data is recorded automatically every x seconds (1 - 900 s), depending on the setting.

While the recording is running, the SD symbol with an arrow appears in the upper left edge of the display:



Manual mode:

In manual mode, when starting the recording, the file to be written to is opened and the header is written, measurement data is only recorded when triggering. During this recording, the SD symbol appears with two bars in the upper left edge of the display:



The following can be triggered via the function menu

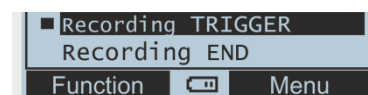

or by clicking on



When a recording success is detected, the display is inverted and the SD symbol appears briefly with an arrow:



The measurement data files are stored as CSV files. CSV stands for comma-separated-values. A CSV file stores tabular data (numbers and text) in plain text. CSV is a simple file format that is supported by many programs. The file format was chosen because it can easily be opened with a spreadsheet program such as Microsoft Excel or OpenOffice.org Calc.

In the following, the contents of the lines are explained in a file excerpt:

```
RMD data file
www.opsytec.de

[RMD Info]
RMD Pro
firmware1 .0.0518
Series N. 00101
Type 814400
Manu.Date11 .10.2019

[Measurement information]
Measurement modeTiming
time interval 60 s
Averaging 0.25s
file name 0:20190101\094228.csv
Decimal separator , [comma]

[CH1 Info]
Sensor typelgang , LUX, RM Digital Sensor
Type 814461
serial number 00135
Calibration date10 .05.2019
Unit klx
Wavelength range380 - 780 nm
Measuring range0-2000 klx

[CH2 Info]
Sensor typelgang , UV-C, RM Digital Sensor
Type 814410
serial number 00115
Calibration date10 .05.2019
Unit W/cm2
Wavelength range200 - 280 nm
Measuring range0-2000 mW/cm2

***File open***01 .01.201909 :42:28
*****
*
    Date [DD.MM.YYYY]      Time [HH:MM:SS]      CH1: LUX [klx] CH2: UVC [W/cm2]      Can
CH1: LUX [klxs]      Can CH2: UVC [J/cm2]      Temp. CH1 [°C] Temp. CH2 [°C]
    01.01.201909 :42: 280,33900      ,339022,422 ,6
    01.01.201909 :43: 280,3400      ,679022,522 ,6
    01.01.201909 :44: 280,3401      ,019022,522 ,6
    01.01.201909 :45: 280,33901      ,358022,422 ,6
    01.01.201909 :46: 280,33901      ,697022,522 ,6
    01.01.201909 :47: 280,33902      ,036022,522 ,6
    01.01.201909 :48: 280,33902      ,375022,522 ,6

***File closed***      01.01.201909 :49:27
```

Information about the handset used

The settings used for data recording, analogous to the Info Window **Menu** -> Data recording -> Information

Information about the sensors used.

### 8.4.2 Data recording via USB

Data recording via USB can be started via a COM interface. The measured values; offset; dose; min.; max. and the temperature (for both sensors) are transmitted, a semicolon serves as separator.

The recording is stopped by a COM command or by pulling the USB cable.

```
Datarecording[TAB]Start[CRLF]
Sensor1;Messwert [klx];ges.Offset;Dosis[klxs];Min.;Max.;Temp.[Grad C];Sensor2;Messwert
[W/cm2];ges.Offset;Dosis[J/cm2];Min.;Max.;Temp.[Grad C]
LUX;0.176;0.000;0.000;0.160;0.176;22.3;UVC;0.000;0.000;0.000;0.000;0.000;22.4;
LUX;0.176;0.000;0.000;0.160;0.176;22.3;UVC;0.000;0.000;0.000;0.000;0.000;22.4;
LUX;0.176;0.000;0.000;0.160;0.176;22.3;UVC;0.000;0.000;0.000;0.000;0.000;22.4;
LUX;0.176;0.000;0.000;0.160;0.176;22.3;UVC;0.000;0.000;0.000;0.000;0.000;22.5;
LUX;0.176;0.000;0.000;0.160;0.176;22.3;UVC;0.000;0.000;0.000;0.000;0.000;22.5;
LUX;0.176;0.000;0.000;0.160;0.176;22.3;UVC;0.000;0.000;0.000;0.000;0.000;22.5;
LUX;0.176;0.000;0.000;0.160;0.176;22.3;UVC;0.000;0.000;0.000;0.000;0.000;22.5;
Datarecording[TAB]Stop[CRLF]
```

All commands and responses use TAB (\x09) as separator and are completed by carriage return (\x0d) and line feed (\x0a). Commands that are not recognized are answered with "NACK: no such command". The RMD will not echo the commands.

The following commands are used to control data recording via USB:

- |                               |   |
|-------------------------------|---|
| Datarecording{TAB}Start{CRLF} | → Starts transmission of measurement data every 1 s |
| Datarecording{TAB}Stop{CRLF}  | → Stops sending the measurement data.               |

The following commands can be used while the recording is running:

- |  |   |
|--|---|
| Datarecording{TAB}Dose{TAB}Start{CRLF} | → Starts the dose measurement               |
| Datarecording{TAB}Dose{TAB}Stop{CRLF}  | → Stops the dose measurement                |
| Datarecording{TAB}Dose{TAB}Reset{CRLF} | → Resets the dose measurement               |
| Datarecording{TAB}Minmax{CRLF}         | → Resets the Min and Max values             |
| Set{TAB}Offset{CRLF}                   | → Sets the current measured value as offset |
| Set{TAB}Offset0{CRLF}                  | → Resets the offset                         |

These commands are always applied only to the selected channel or sensor. The channel can be changed with the following commands:

- |                       |                                    |
|-----------------------|------------------------------------|
| Set{TAB}Sensor1{CRLF} | → Switches to channel 1            |
| Set{TAB}Sensor2{CRLF} | → Switches to channel 2            |
| Set {TAB}Both{CRLF}   | → Activates all connected channels |

The following commands, for measurement adjustments and information, should not be sent during a measurement.

- |                                |                              |
|--------------------------------|------------------------------|
| Set{TAB}Averaging{TAB}Xs{CRLF} | → Sets the averaging for all |
|--------------------------------|------------------------------|



	channels.
	Possible averages (X) are 0s, 0.25s, 0.5s 1s or 2s.
Info{TAB}Device{CRLF}	→ General information about the RMD like firmware, serial number, type number and date of manufacture
Info{TAB}Sensor1{CRLF}	→ Gives information about the sensor connected to channel 1: Sensor type, type number, serial number, calibration date, calibration unit, calibrated wavelength and the measuring range
Info{TAB}Sensor2{CRLF}	→ Analog to channel 1
OFF{CRLF}	→ Turns the RMD off
ON{CRLF}	→ Switches the RMD on



The command set can be read out with the `Help{CRLF}` command.

### 8.5 Additional lamp factors\*

(This function is only available with a corresponding sensor with lamps factors)

If a sensor is connected that has stored additional lamp factors there is an additional point in the function menu to switch the factors:

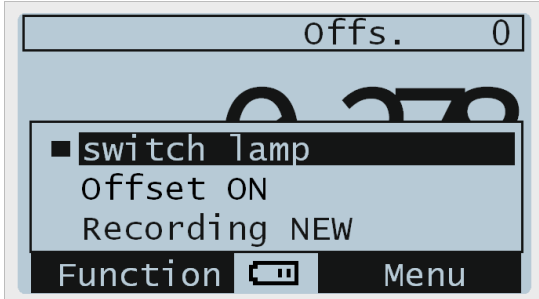

To change a factors click **Function** -> switch lamp

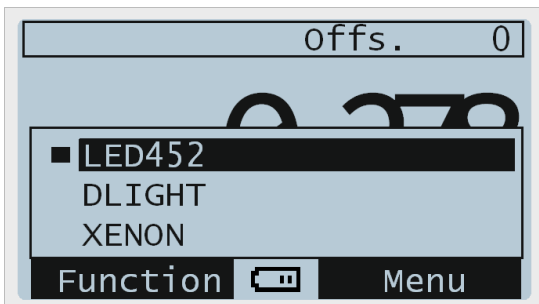

And select the required lamp

It is possible to store up to 10 lamp factors, in one sensor, click arrow up or down to switch between them.

(\* Lamps names exemplary)

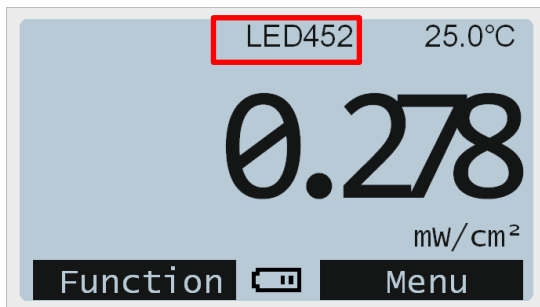

The currently set name of the factor appears wherever the sensor name would be.

### 8.6 Sensors with 2 channels: Erythem und NDT\*

This function is only available for the corresponding sensors:

- NDT (365 nm + LUX) 315 - 400 nm, 380 -780 nm
- Erythema + UVA 200 - 400 nm, Ery( $\lambda$ )
- Special sensors

The sensors with 2 channel differ in the measurement screen from the simple sensors.

### 8.6.1 Erythema sensor

In addition to the measured irradiances of the two channels, the erythema sensors also displayed the sum of these irradiances on the measurement screen.

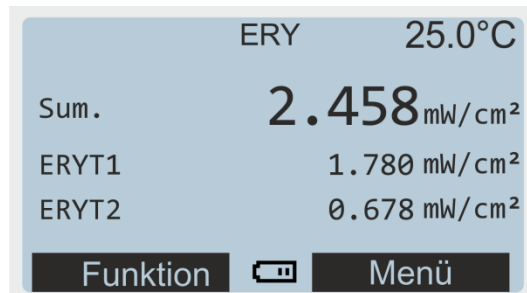

The measurement screens of dose, minimum and maximum measurements are analogous to the irradiance measurement screen. The current measurement value is not displayed here.

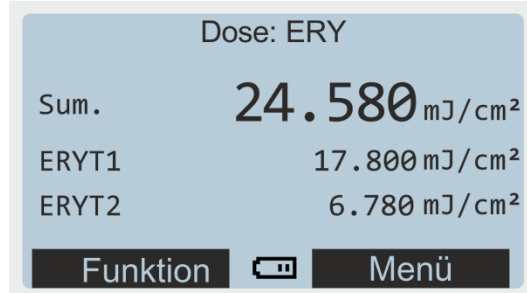

In case of dual display of two sensors on one measurement screen only the sum is displayed.

### 8.6.2 NDT

The NDT sensors do not form a sum because of the different units, therefore only the two channels are shown on the display.

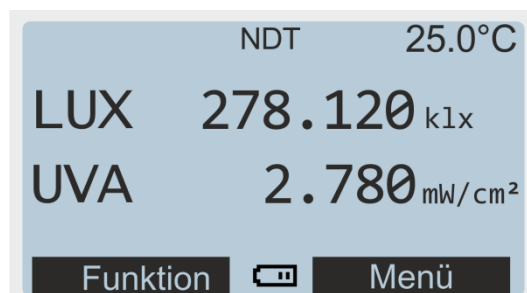

The same applies to the dose, minimum and maximum display. Also here the actual measured values are not shown.

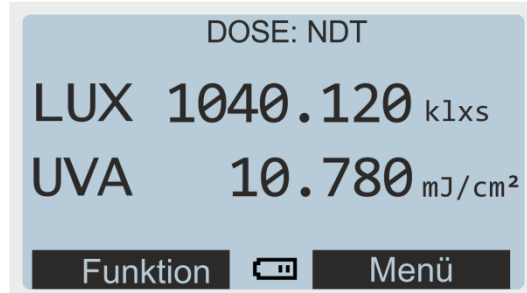

With the dual display of two sensors on one measurement screen, both channels are always displayed one below the other.

## 8.7 Switch off

Press and hold the button to  switch off the unit. All recordings and measurements are terminated and saved if necessary.

## 8.8 Charging the battery

The handset can be charged via USB either with the supplied power supply or on a PC. This should happen at the latest when the battery symbol starts flashing.

Battery symbol:



The battery is empty and should be charged urgently, symbol flashes



Battery is discharging



Battery is on current and fully charged



Battery Charging



Switched off when the unit is powered

## 9 Software

The software is used to read out and control the RMD Pro with the PC. The software enables:

- Display and export measured values
- Switching data recording on and off
- To change the settings

### 9.1 Installing software

**Proceed as follows for the installation:**

- 1.) Uninstall any old versions of the software first.
- 2.) If necessary, disconnect the RMD Pro from the PC.
- 3.) Start the installation with "Setup.exe" in the root directory of the USB stick. Follow the instructions of the installation program.
- 4.) After the installation is complete, connect the RMD Pro to the PC. The driver installation takes place automatically under Windows 10.
- 5.) Connect the RMD Pro to the PC and start the software.

### 9.2 Operation

The operation of the software is divided into tabs:

- Control of the measuring device / measurements on the PC
- Information about RMD Pro and the sensors
- Setting of the measured value output
- Output of the measurements the table
- Output of the measurements the graph

Measurements can be started and stopped by software and the settings for the measurements can be made.

### 9.2.1 Device control and information

The following figure shows in the upper part the "Settings" for controlling the RMD Pro radiometer according to the previously described device settings.

Below that, "Information" with data on the sensors and the RMD Pro radiometer is displayed

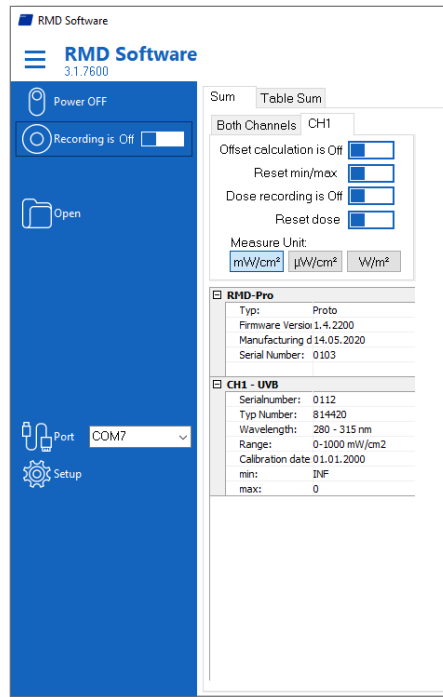
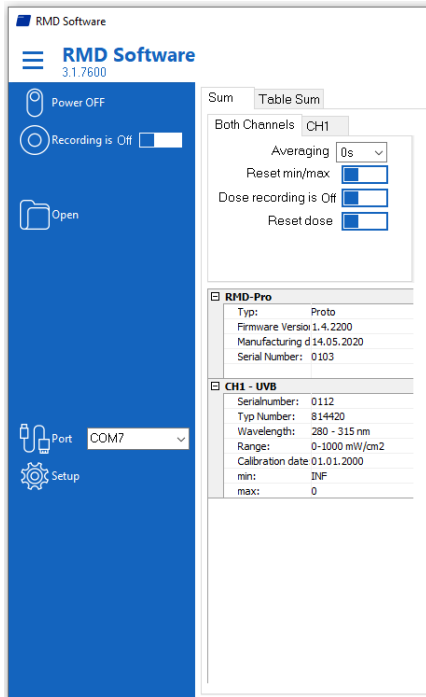

### 9.2.3 Measurement

The following figure shows the "Measurement" tab with the current measurement value as a graph. The settings for the graph can be found under "Setup".

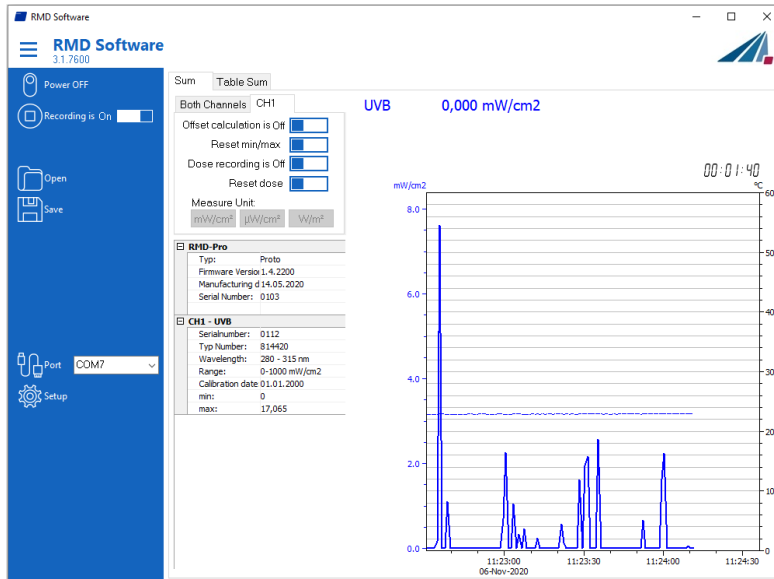

The following figure shows setting options for the graph

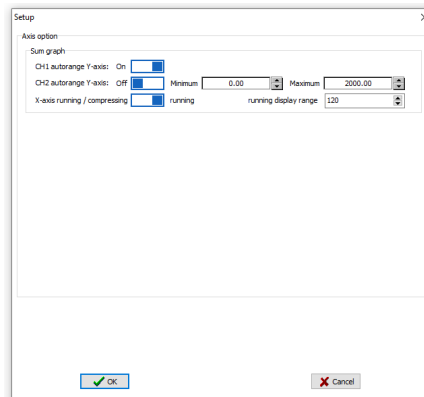

The following figure shows the "Table" tab with the last measured values.

The screenshot shows the RMD Software interface. On the left is a blue sidebar with icons for Power OFF, Recording is Off, Open, Save, Print Report, Save Report, Port (COM7), and Setup. The main window displays a table with the following data:

Date	Time	UVB	nC	Dose UVB	Dose nC	Temp. UVB	Temp. nC
06.11.2020	11:31:11	0.000				23	
06.11.2020	11:31:12	0.010				23	
06.11.2020	11:31:13	0.000				22.9	
06.11.2020	11:31:14	0.000				22.9	
06.11.2020	11:31:15	0.000				22.9	
06.11.2020	11:31:16	0.000				23	
06.11.2020	11:31:17	2.527				23	
06.11.2020	11:31:18	0.000				22.9	
06.11.2020	11:31:19	0.000				23	
06.11.2020	11:31:20	0.000				22.9	
06.11.2020	11:31:21	0.000				22.9	
06.11.2020	11:31:22	0.000				22.9	
06.11.2020	11:31:23	0.000				22.9	
06.11.2020	11:31:24	0.000				22.9	
06.11.2020	11:31:25	0.000				23	
06.11.2020	11:31:26	0.000				23	
06.11.2020	11:31:27	0.000				23	
06.11.2020	11:31:28	0.000				22.9	
06.11.2020	11:31:29	0.000				23	
06.11.2020	11:31:30	0.000				23	
06.11.2020	11:31:31	0.000				23	
06.11.2020	11:31:32	0.000				22.9	
06.11.2020	11:31:33	0.000				23	
06.11.2020	11:31:34	0.000				23	
06.11.2020	11:31:35	0.000				22.9	
06.11.2020	11:31:36	3.057				23	
06.11.2020	11:31:37	0.486				23	
06.11.2020	11:31:38	0.000				22.9	
06.11.2020	11:31:39	0.000				22.9	

### 9.3 SD card and data export

Measurements are stored on the internal SD card. If the RMD Pro is connected to the PC, it is recognized as a drive.

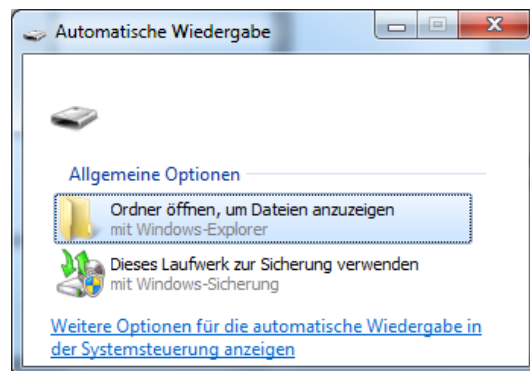

The data files are saved as CSV files. CSV stands for comma-separated-values. A CSV file stores tabular data (numbers and text) in plain text. This makes a CSV file easy to read (e.g. in a text editor). CSV is a simple file format that is supported by many programs. The file format was chosen because it can easily be opened with a spreadsheet like Microsoft Excel or OpenOffice.org Calc.

In the software, measurements can be exported using the Save / Save As function or as CSV data. For easy import, the format can be adjusted in the "Settings" menu.



## 10 Technical data



The pin assignment for special versions may vary and can be found in the "Technical Drawing" appendix.

General data	
Ambient temperature	0 to 60 °C
Storage temperature, approx.	-20 to +60 °C
Air humidity	0% to 80% relative humidity, non-condensing
Type of structure	Handset
Mounting position	any
Dimensions, control electronics	160 x 85 x 35 mm
Weight	Approx. 250 g
Display	graphic display, 128 x 64 px
Noise emission	Lpa < 70 dB at the workplace in normal operation according to DIN 45635 T. 19

Measurement	
Display output	1 + 2 channels Irradiance + Dose min/max irradiance
internal storage	8 GB
Data recording rate	adjustable: 1 s - 15 min
Recording duration	> 2400 h

Connections	
Mains voltage and frequency, plug-in power supply	100-240VAC / 50-60 Hz
Sensor connections	2 pieces, fully digital
PC interface	USB 2.0
Maximum input power	See the type plate of the plug-in power supply unit
Power supply	Integrated Li-Ion battery,

USB-Connection / Hardware- Software requirements	
PC requirements	min Intel CORE i3, 2 GB Ram, >40 Gb HDD
Operating system	Windows 10 with .NET Framework > 4.0

<b>TECHNICAL DATA SENSORS</b>	
Measuring range	See type plate The effective resolution and detection limit is type dependent and can be improved with longer averaging time.
Resolution	0.001 $\mu\text{W}/\text{cm}^2$
Dose measuring range	0 - 100 $\text{MJ}/\text{cm}^2$
Illuminance measurementsb.	0 - 500,000 lx
Dynamic range	up to $10^7$
AD conversion	24 bit
Temperature sensor	integrated
Dimensions	$\varnothing$ 40 mm, h 35 mm
Optical surface	$\varnothing$ 6 mm
Weight	160 g
Connection cable	2 m
Operating temperature	0 to 40 °C
Storage temperature	-20 to 60 °C
Air humidity	<80%, non-condensing



The technical data for special versions may vary and can be found in the appendices to the special versions.

<b>Spectral ranges of the sensors</b>	
UVC	200 - 280 nm
UVB	280 - 315 nm
UVA	315 - 400 nm
UVA+	330 - 455 nm
UVBB (Broadband)	230 - 400 nm
VISB	400 - 480 nm
VISBG	400 - 570 nm
LUX	380 - 780 nm, $V(\lambda)$
NDT (365 nm + LUX)	315 - 400 nm, 380 - 780 nm
Erythema + UVA	200 - 400 nm, $Ery(\lambda)$

<b>Firmware version</b>	
Firmware version	1.3.2162

## 11 Errors / faults

The following notes and error messages are directed to the user. The explanations should help to ensure proper operation. Possible reasons and remedies are given.

Function / Display	Meaning	Measures
The RMD Pro cannot be switched on	Battery empty  malfunction	Charge the battery.  Reset the device. To do this, press the reset button on the back (to the right of the nameplate) with a thin object.
The irradiance is too low	Sensor aging  Sensor dirty	Have the sensor recalibrated  Clean sensor (e.g. with ISOPROPANOL)
Sensor is not displayed	Sensor not recognized	Reconnect sensor  Restart RMD Pro
SD card is not displayed anymore		Reconnect SD card  Reset the device.

## 12 Maintenance & Cleaning



This chapter is intended for qualified users with maintenance tasks.

The system is largely maintenance-free. Clean the optical components only if necessary.

The RMD Pro is a system that requires only occasional cleaning as maintenance according to need and calibration.

For cleaning, we recommend that this is only carried out when necessary and not regularly, as the sensor surface is (scratch) sensitive.

The following table gives some maintenance steps as a recommendation:

No.	Maintenance item	Procedure	Recommended frequency
1	Sensor check	Check sensors, must be free of dirt, otherwise clean / recalibrate.	Monthly
2	Cleaning of the components	Visual inspection The surfaces must be clean. Cleaning only as required.	Monthly
3		If cleaning is necessary, use compressed air or isopropanol (UV-IR grade) and a very soft paper towel.	If required
4	Calibration	Check the calibration by comparison measurement or calibration date.	If required
5		If recalibration is necessary, send to the manufacturer	Annually
6	Testing the cables	Check all wiring connections for possible damage or loose contacts. Replace if necessary.	All 6 weeks

Only carry out cleaning work on the sensor as required. This gives you the best possible stability. Clean exclusively with isopropanol (UV-IR-GRADE), with oil-free compressed air or with clean, lint-free cloths.

Wear clean, lint-free gloves.

Apply the cleaning agent only to the cloth, only moisten.

The cleaning agent could get inside and cause damage to property.

Wipe with little pressure, in a circular motion over the surfaces.

Then remove all residues of the cleaning agent.

	<b>⚠ CAUTION</b>
	<p><b>The surfaces of the sensors can be affected by UV radiation heat it up. This can cause burns on contact.</b></p> <p>Therefore please note:</p> <ul style="list-style-type: none"> <li>- wear protective gloves if necessary</li> <li>- If necessary, observe the cooling phase</li> </ul>

	<b>CAUTION</b>
	<p><b>Risk of damage</b></p> <ul style="list-style-type: none"> <li>• Skin grease and dirt are absorbent in the UV and visible spectral range.</li> <li>• Avoid fingerprints on the optically active sensor surface. If necessary, the components must be carefully cleaned with isopropanol.</li> </ul>

## 12.1 Calibration

We recommend to have the sensors used calibrated every year by the manufacturer to ensure accurate measurement results.

## 12.2 Firmware update

It is possible to update the firmware of the RMD via USB. For this purpose the RMD must be connected via USB to a suitable PC running the update program.

In addition, the RMD must be put into update mode via menu, the update mode is secured by the password:

1. **Menu-> Settings->**

Firmware update

Use the arrow keys and to▶enter the password.

By confirming the password with **OK**, the device goes into update mode. This mode can only be interrupted by a reset!

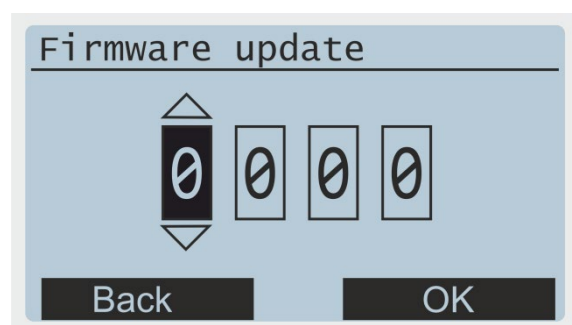

The password for unlocking the firmware update is the last four digits of the serial number.

- Open the software and click **Next**

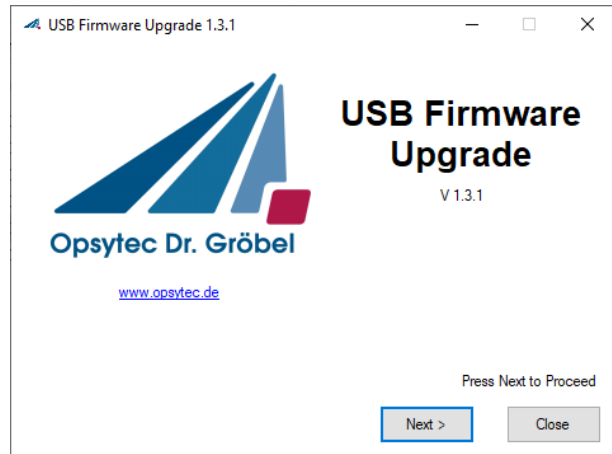

- Accept license and continue
- Select the new firmware as TEXT file by **browsing**.  
If the device is in update mode and has been found, the update can be started with **Upgrade Firmware**.

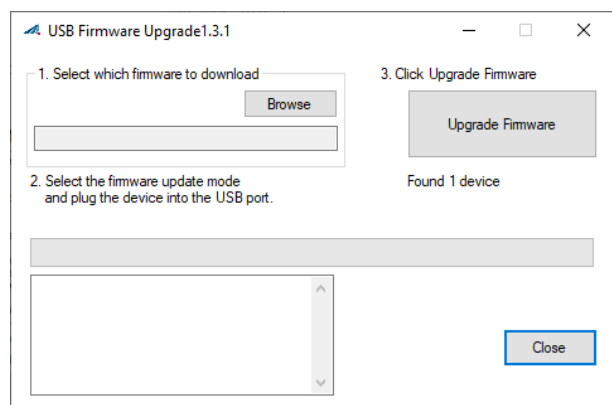

During the update, the USB connection must not be disconnected and the PC must not be switched off!

- The loading bar shows the progress of the update, only when the info window says "Done" can the RMD be removed and the software closed.

After successful firmware update the RMD restarts and the date and time must be entered again.

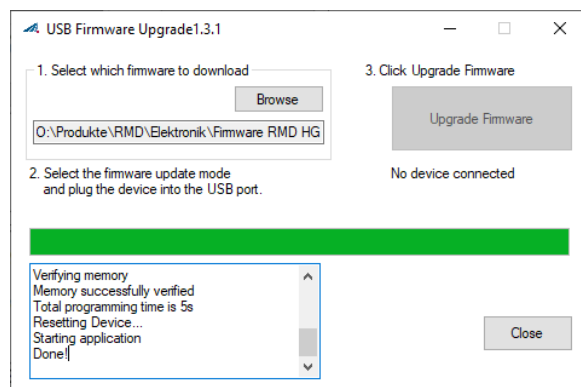

## 13 Spare parts



**Please contact us for replacement orders:**

Opsytec Dr. Gröbel GmbH

At Hardtwald 6-8

76275 Ettlingen



Germany

Phone +49 - 7243 - 94 783 - 50

Fax +49 - 7243 - 94 783 - 65

Visit us on the Internet: [www.opsytec.de](http://www.opsytec.de)

When operating with damaged components or foreign components, no guarantee can be given for the correctness of the measured values. Furthermore, compatibility with foreign components is not guaranteed.

 <b>CAUTION</b>	
	<p><b>Damaged components or foreign components</b></p> <p>When operating with damaged components or foreign components, operational safety is not guaranteed.</p> <p>There is a risk of injury and damage to property.</p> <ul style="list-style-type: none"><li>- Replace damaged parts immediately</li><li>- Only use original parts, spare parts and accessories</li></ul>

## 14 Declaration of conformity



Manufacturer :	Company name: Opsytec Dr. Gröbel GmbH Road: Am Hardtwald 6-8 Place: 76275 Ettlingen Country: Germany
Authorized person for compiling the technical documentation:	Company name: Opsytec Dr. Gröbel GmbH Road: Am Hardtwald 6-8 Place: 76275 Ettlingen Country: Germany
product:	Radiometer RMD Pro with sensors
Type designation:	RMD Pro
Type number:	814400 XXXX 8144XX XXXX

The manufacturer hereby declares that we have developed, designed and produced the above-mentioned product(s) under our sole responsibility and that the product complies with the following standard(s) or directive(s) in this declaration:

### **2014/35/EU**

"Directive of the European Parliament and of the Council on the harmonisation of the laws of the Member States relating to the provision of electrical equipment for household and commercial use Equipment for use within certain voltage limits on the market (Low Voltage Directive)".

### **2014/30/EU**

"Directive of the European Parliament and of the Council on electromagnetic compatibility (EMC Directive, recast)".

The conformity of the designated product with the provisions of the Directive is demonstrated by full compliance with the following standards:

DIN EN 60204-1: Safety of machinery - Electrical equipment of machines -  
Part 1: General requirements (IEC 60204-1:2005, modified)

Ettlingen, 18.04.2018

signed. Dr. Mark Paravia



